



EXHIBITION CATALOG





Why should you participate at a trade fair?

A trade fair is the ideal place where you can promote your product range and make new business partners. Also, you can launch your new releases in your field of business as well as find out what is your competition up to.

Participating to a trade fair also gives you the opportunity to:

- ✓ directly interact with a potential client or business partner;
- ✓ make yourself noticed by your target market segment;
- ✓ directly launch your new products;
- ✓ strengthen your relationships with existing business partners;
- ✓ obtain a quick feedback

Regardless of how many advantages could the nowadays advanced technology offer us, it will not equal the impact of direct interaction.

Your stand - your image

The success of an event or an exhibition also depends on your exhibition stand.

In order for your exhibition stand to make an impact on the visitors, you must have the following details very clearly defined:

LOCATION

- ✓ What are the dimensions of the area you have available?
- ✓ How high are you allowed to make your exhibition displays?
- ✓ How many open sides / access sides will your have to your exhibition stand?

DESIGN

- ✓ What types of systems do you want (walls, arches, desks, atypical shapes, etc.)?
- ✓ How do you want to position them based on the available space?
- ✓ How illuminated do you want to have your exhibition stand?
- ✓ Are you taking into account other elements such as a support for brochures, etc.?

USE OF THE STAND

- ✓ How often do you use it? Can it be reused? Can it be easily maintained /cleaned?
- ✓ How do you transport it? An ideal stand can be easily transported and requires a small storage space.

BUDGET

- ✓ Do you intent to reuse the systems? Can you print both sides of the textile cover?
- ✓ Take into account systems that allow for individual use as well as in combinations of various dimensions.

Reasons to choose a FormTex exhibition stand



Portable



Small Cost



Rapid and easy assembling



Variety of shapes



Easy and compact



Reuse

Assembling the Click structures

The FormTex Click portable exhibition systems represent an innovative mode of presenting a brand or a message. Each system consists of a modular aluminum structure, tightly covered with an elastic fabric, printable with high quality images and text.

Assembling the structures is very easy - the internal aluminum structure requires only connecting the edges of the segments, following the numbering visible on them (like a children's puzzle). Once the structure assembled, the textile is pulled over it, the last step being to close the zipper on the textile, thus ensuring that it stays tight on the structure.

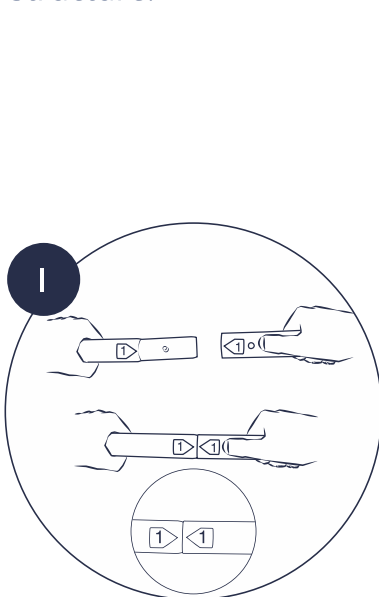

Assemble the interior aluminum structure by joining the segments according to their numbering.

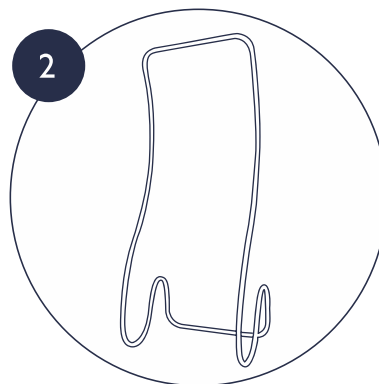

Connect all pieces until you've created the complete shape of the structure.



Make sure your hands are clean. It is recommended the use of the gloves that are in the package.

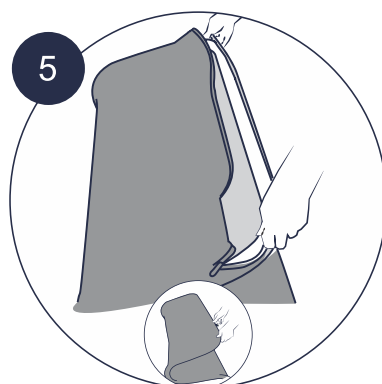

Close the zipper at the other end of the textile.
Your FormTex Click structure is ready!

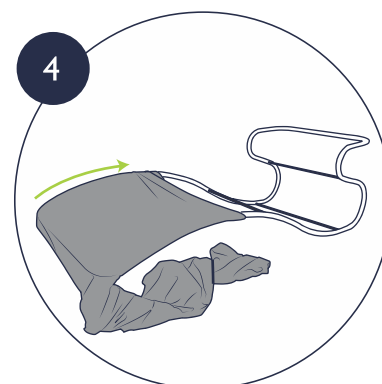

Pull the textile onto the aluminum frame, making sure it is tight.

Small stands

Expo stand Ava



The product comes in bags



Different dimensions



Fast and easy assembling

Stand for an exhibition area of 3 x 2 m, 3 open sides, consisting of:

- ✓ Straight wall, 2 x 2.3 m (L x h), printed on one side - 1 piece
- ✓ Straight desk - 1 piece
- ✓ Semiarch 1 x 2.3 x 1.5 m (L x h x d) printed on both sides - 1 piece
* maximum recommended weight of the screen is 20 kg and the diagonal should be 50 to 110 cm
- ✓ 3D Straight wall 1 x 3 m (L x h), printed on one side- 1 piece
- ✓ FormTex accessories - LED spot lights - 2 pieces, brochure holder

Customized dimensions available upon request



Expo stand Eleos



Best Sellers



The product comes in bags



Different dimensions



Fast and easy assembling

Stand for an exhibition area of 3 x 2 m, 3 open sides, consisting of:

- ✓ Straight wall, 3 x 2.3 m (L x h), printed on one side - 1 piece
- ✓ Straight desk - 1 piece
- ✓ Semiarch 1 x 2.3 x 2 m (L x h x d) printed on both sides - 1 piece
* maximum recommended weight of the screen is 20 kg and the diagonal should be 50 to 110 cm
- ✓ FormTex accessories - LED spot lights - 2 pieces, brochure holder

Customized dimensions available upon request



Expo stand Siro



The product comes in bags



Different dimensions



Fast and easy assembling

Stand for an exhibition area of 3 x 2 m, 3 open sides, consisting of:

- ✓ 3D Straight Wall, 1 x 3 m (L x h), printed on one side – 1 piece
* maximum recommended weight of the screen is 20 kg and the diagonal should be 50 to 110 cm
- ✓ Straight wall, 1 x 2.3 m (L x h) printed on one side – 2 pieces
- ✓ Straight desk – 1 piece
- ✓ FormTex accessories – LED spot lights - 2 pieces, brochure holder, TV support for 3D wall – 1 piece



Customized dimensions available upon request

Expo stand Nova



The product comes in bags



Different dimensions



Fast and easy assembling

Stand for an exhibition area of 3 x 2 m, 2 open sides, consisting of:

- ✓ Straight wall, 2 x 2.3 m (L x h), printed on one side – 1 piece
- ✓ Straight wall, 1.5 x 2.3 m (L x h), printed on one side – 1 piece
- ✓ 3D Straight Wall, 1 x 3 m (L x h), printed on one side – 1 piece
- ✓ Oval desk – 1 piece
- ✓ FormTex accessories – LED spot lights - 3 pieces, brochure holder



Customized dimensions available upon request

Expo stand Cara



The product comes in bags



Different dimensions



Fast and easy assembling

Stand for an exhibition area of 3 x 2 m, 2 open sides, consisting of:

- ✓ Straight wall, 2 x 2.3 m (L x h), printed on one side – 1 piece
- ✓ 3D Straight Wall, 1 x 3 m (L x h), printed on one side – 1 piece
 - * maximum recommended weight of the screen is 20 kg and the diagonal should be 50 to 110 cm
- ✓ Straight wall, 1 x 2.3 m (L x h) printed on one side – 2 pieces
- ✓ Straight desk – 1 piece
- ✓ FormTex accessories – LED spot lights - 4 pieces, brochure holder, TV support for 3D wall – 1 piece, 90° connecting set - 1 set

Customized dimensions available upon request



Expo stand Silas



Best Sellers



The product comes in bags



Different dimensions



Fast and easy assembling

Stand for an exhibition area of 4 x 2 m, 2 open sides, consisting of:

- ✓ Straight wall, 3 x 2.3 m (L x h) printed on one side – 1 piece
- ✓ Straight wall, 1 x 2.3 m (L x h) printed on one side – 1 piece
- ✓ Oval desk – 1 piece
- ✓ 3D Straight Wall, 1 x 3 m (L x h) – 2 pieces
 - * maximum recommended weight of the screen is 20 kg and the diagonal should be 50 to 110 cm
- ✓ FormTex accessories – LED spot lights - 3 pieces, brochure holder 90° connecting set - 1 set, rack with shelves - 1 piece TV Support for 3D wall - 2 pieces

Customized dimensions available upon request

Possible to print on both sides



Expo stand Alma



The product comes in bags



Different dimensions



Fast and easy assembling

Stand for an exhibition area of 3 x 3 m, with 3 open sides, consisting of:

- ✓ Straight wall, 2 x 2.3 m (L x h), printed on one side - 1 piece;
- ✓ Straight desk - 1 piece;
- ✓ Semiarch printed on both sides - 1 piece
*maximum recommended weight of the screen is 20 kg and the diagonal should be 50 to 110 cm
- ✓ 3D Straight wall 1 x 3 m (L x h), printed on one side - 1 piece;
- ✓ FormTex accessories: LED spot lights - 2 pieces; brochure holder - 1 piece

Customized dimensions available upon request



Expo stand Alpha



Best Sellers



The product comes in bags



Different dimensions



Fast and easy assembling

Stand for an exhibition area of 3 x 3 m, with 3 open sides, consisting of:

- ✓ Straight wall, 3 x 2.3 m (L x h), printed on one side - 1 piece
- ✓ Straight desk - 1 piece
- ✓ Semiarch 1 x 2.3 x 2.6 m (L x h x d) printed on both sides - 1 piece
*maximum recommended weight of the screen is 20 kg and the diagonal should be 50 to 110 cm
- ✓ FormTex accessories: LED spot lights - 2 pieces; brochure holder - 1 piece

Customized dimensions available upon request

€



Expo Stand Maia



Best Sellers



The product comes in bags



Different dimensions



Fast and easy assembling

Stand for an exhibition area of 3 x 3 m, with 2 open sides, consisting of:

- ✓ Straight wall, 2 x 2.3 m (W x H), custom printed one side - 2 pieces
- ✓ Straight Arch (1 x 3 x 3 m - W x H x H), custom printed both sides - 1 piece
- ✓ 3D wall, 1 x 3 m (W x H), custom printed one side - 1 piece
*maximum recommended weight of the screen is 20 kg and the diagonal should be 50 to 110 cm
- ✓ Oval desk custom-printed - 1 piece
- ✓ FormTex accessories: - LED spotlights - 8 pieces, 90° connection accessories - 1 set, TV stand

Customized dimensions available upon request

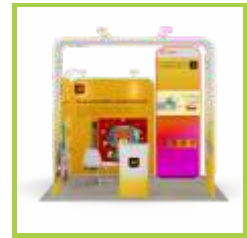

Expo stand Tea



The product comes in bags



Different dimensions



Fast and easy assembling

Stand for an exhibition area of 3 x 3 m, with 3 open sides, consisting of:

- ✓ Straight wall, 3 x 2.3 m (L x h), custom printed on one side - 1 piece
- ✓ Straight Arch (1 x 2.3 x 3 m - W x H x H), custom printed both sides - 1 piece
- ✓ Oval desk - 1 piece
- ✓ FormTex accessories - LED spotlights - 3 pieces, brochure stand, TV stand with shelves

Customized dimensions available upon request



Expo Stand Apollo



Best Sellers



The product comes in bags



Different dimensions



Fast and easy assembling

Stand for an exhibition area of 3 x 3 m, with 2 open sides, consisting of:

- ✓ Straight wall, 3 x 2.3 m (L x h), printed on one side - 2 pieces;
- ✓ Semiarch 1 x 2.3 x 2.6 m (L x h x d) printed on both sides - 1 piece;
*maximum recommended weight of the screen is 20 kg and the diagonal should be 50 to 110 cm
- ✓ Oval desk - 1 piece;
- ✓ FormTex accessories: LED spot lights - 4 pieces;
90° connecting set - 1 set

Possible to print on both sides



Customized dimensions available upon request

Expo stand Delta



The product comes in bags



Different dimensions



Fast and easy assembling

Stand for an exhibition space 3 x 3 m, 2 open sides, consisting of:

- ✓ Straight wall, 3 x 2.3 m (W x H), custom printed one side - 1 piece
- ✓ Straight wall, 1.5 x 2.3 m (W x H), custom printed one side - 1 piece
- ✓ 3D wall, 1.5 x 3 m (W x H), custom printed one side - 1 piece
* We recommend a maximum 20 kg screen, diagonal 50 - 110 cm
- ✓ Oval desk custom-printed - 1 piece
- ✓ FormTex accessories - LED spotlights - 4 pieces, brochure stand, 90° connection accessories - 1 set, TV stand



Customized dimensions available upon request

Expo stand Leto



The product comes in bags



Different dimensions



Fast and easy assembling

Stand for an exhibition area of 3 x 3 m, with 2 open sides, consisting of:

- ✓ Straight wall, 2.5 x 2.3 m (L x h), printed on one side - 1 piece
- ✓ 3D Straight wall, 2 x 2.3 m (L x h), printed on one side - 1 piece
- ✓ Straight desk - 1 piece
- ✓ Desk shelves - 1 piece
- ✓ FormTex accessories: LED spot lights - 5 pieces; brochure holder - 1 piece; TV support with shelves - 1 piece

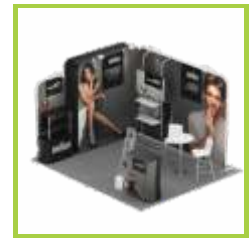

Customized dimensions available upon request

Expo stand Selene



The product comes in bags



Different dimensions



Fast and easy assembling

Stand for an exhibition area of 3 x 3 m, with 2 open sides, consisting of:

- ✓ Asymmetric wall, 1.5 x 2.2/2.5 m (L x h), printed on one side - 2 pieces
- ✓ 3D Straight wall, 1.5 x 3 m (L x h), printed on one side - 1 piece
* maximum recommended weight of the screen is 20 kg and the diagonal should be 50 to 110 cm
- ✓ Straight desk - 1 piece
- ✓ FormTex accessories: Tower shelves - 1 piece, brochure holder - 1 piece, TV support for 3D wall - 1 piece



Customized dimensions available upon request

Expo stand Dante



The product comes in bags



Different dimensions



Fast and easy assembling

Stand for an exhibition space 3 x 3 m, 2 open sides, consisting of:

- ✓ Straight wall, 3 x 2.3 m (W x H), custom printed one side - 1 piece
- ✓ Straight wall, 1.5 x 2.3 m (W x H), custom printed one side - 1 piece
- ✓ 3D wall, 1.5 x 3 m (W x H), custom printed one side - 1 piece
* We recommend a maximum 20 kg screen, diagonal 50 - 110 cm
- ✓ Oval desk custom-printed - 1 piece
- ✓ FormTex accessories - LED spotlights - 4 pieces, brochure stand, 90° connection accessories - 1 set, TV stand



Customized dimensions available upon request



Expo stand Atlas



The product comes in bags



Different dimensions



Fast and easy assembling

Stand for an exhibition area of 4 x 3 m, with one open side, consisting of:

- ✓ Straight wall, 4 x 2.3 m (L x h), printed on one side - 1 piece;
- ✓ Straight wall, 3 x 2.3 m (L x h), printed on one side - 2 pieces
- ✓ Straight desk - 1 piece
- ✓ FormTex accessories: LED spot lights - 6 pieces; brochure holder - 1 piece; TV support with shelves; 90° connecting set - 2 sets

Possible to print on both sides



Customized dimensions available upon request



Medium Stands

Expo stand Atena



The product comes in bags



Different dimensions



Fast and easy assembling

Stand for an exhibition area of 4 x 4 m, with 3 open sides, consisting of:

- ✓ Straight wall, 2 x 2.3 m (W x H), custom printed one side - 2 pieces
- ✓ Round arch 4 x 3 x 0.9 m (L x h x w), custom printed one side - 1 piece
- ✓ Oval desk custom-printed - 1 piece
- ✓ FormTex accessories - LED spotlights - 4 pieces, brochure stand, 90° connection accessories - 1 set



Possible to print on both sides



Expo stand Vesta



The product comes in bags



Different dimensions



Fast and easy assembling

Stand for an exhibition area of 4 x 4 m, with 2 open sides, consisting of:

- ✓ Straight wall, 1 x 2.3 m (W x H), custom printed one side - 1 piece
- ✓ Straight wall, 2 x 2.3 m (W x H), custom printed one side - 1 piece
- ✓ Straight wall, 3 x 2.3 m (W x H), custom printed one side - 1 piece
- ✓ 3D wall, 1 x 3 m (W x H), custom printed one side - 2 pieces
* maximum recommended weight of the screen is 20 kg and the diagonal should be 50 to 110 cm
- ✓ Oval desk custom-printed - 1 piece
- ✓ FormTex accessories: LED spotlights - 5 pieces, brochure stand, 90° connection accessories - 1 set, TV stand 2 pieces, rack with shelves



Expo stand Lelia



Best Sellers



The product comes in bags



Different dimensions



Fast and easy assembling

Stand for an exhibition area of 5 x 3 m, with 3 open sides, consisting of:

- ✓ Straight wall, 2 x 2.3 m (L x h), printed on one side - 2 pieces
- ✓ Straight desk - 2 pieces
- ✓ Semiarch 1 x 2.3 x 2.6 m (L x h x d) printed on both sides - 1 piece
*maximum recommended weight of the screen is 20 kg and the diagonal should be 50 to 110 cm
- ✓ 3D Straight wall, 1 x 3 m (L x h), printed on one side - 1 piece
- ✓ FormTex accessories: LED spot lights - 4 pieces



Customized dimensions available upon request

Expo stand Nero



The product comes in bags



Different dimensions



Fast and easy assembling

Stand for an exhibition area of 5 x 3 m, with 3 open sides, consisting of:

- ✓ Straight wall, 3 x 2.3 m (L x h), printed on one side - 1 piece
- ✓ Straight desk - 1 piece
- ✓ 3D round wall, 3 x 3 m (L x h), printed on one side - 1 piece
- ✓ Triangle column, 1 x 3m (L x h), printed on all sides - 1 piece
- ✓ FormTex accessories: LED spot lights - 6 pieces; TV support with shelves - 1 piece



Customized dimensions available upon request

Expo stand Flora



The product comes in bags



Different dimensions



Fast and easy assembling

Stand for an exhibition area of 5 x 3 m, with 3 open sides, consisting of:

- ✓ Asymmetric wall, 1.5 x 2.2/2.5 m (L x h), printed on one side - 2 pieces
- ✓ 3D Straight wall, 2 x 2.5 m (L x h), printed on one side - 1 piece
- ✓ Straight desk - 1 piece
- ✓ Square column, 1 x 3 m (L x h), printed on all sides - 1 piece
- ✓ FormTex accessories: LED spot lights - piece;
- TV support for 3D wall - 1 piece



Customized dimensions available upon request



Expo stand Leo



Best Sellers



The product comes in bags



Different dimensions



Fast and easy assembling

Stand for an exhibition area of 5 x 3 m, with 3 open sides, consisting of:

- ✓ Straight wall, 3 x 2.3 m (L x h), printed on one side - 1 piece;
- ✓ 3D Straight wall 1 x 3m (L x h), printed on one side - 2 pieces
- ✓ Semiarch 1 x 2.3 x 2.6 m (L x h x d) printed on both sides - 2 pieces
*maximum recommended weight of the screen is 20 kg and the diagonal should be 50 to 110 cm
- ✓ Straight desk – 1 piece
- ✓ FormTex accessories: LED spot lights - 4 pieces;
- brochure holder - 1 piece



Customized dimensions available upon request



Expo stand Bia



The product comes in bags



Different dimensions



Fast and easy assembling



Stand for an exhibition area of 5 x 3 m, with 3 open sides, consisting of:

- ✓ Asymmetric wall, 1.5 x 2.3/2.5 m (W x H), custom printed one side - 2 pieces
- ✓ Straight wall, 2 x 2.3 m (W x H), custom printed one side - 1 piece
- ✓ Semiarch custom printed custom printed one side - 1 piece
*maximum recommended weight of the screen is 20 kg and the diagonal should be 50 to 110 cm
- ✓ Oval desk custom-printed - 2 pieces
- ✓ FormTex accessories - LED spotlights - 4 pieces

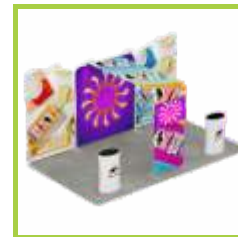

Expo stand Neptune



The product comes in bags



Different dimensions



Fast and easy assembling



Stand for an exhibition area of 4 x 4 m, with 2 open sides, consisting of:

- ✓ Straight wall, 4 x 2.3 m (L x h), printed on one side - 1 piece
- ✓ Straight wall, 2 x 2.3 m (L x h), printed on one side - 1 piece
- ✓ 3D round wall, 3 x 3 m (L x h), printed on one side - 1 piece
- ✓ Oval desk - 1 piece
- ✓ FormTex accessories: LED spot lights - 6 pieces; brochure holder - 1 piece; TV support with shelves; 90° connecting set



Customized dimensions available upon request

Large Stands

Expo stand Vita



Best Sellers



The product comes in bags



Different dimensions



Fast and easy assembling

Stand for an exhibition area of 6 x 3 m, with 3 open sides, storage area, consisting of:

- ✓ Straight wall, 6 x 2.3 m (L x h), printed on one side - 1 piece
- ✓ Straight wall, 2 x 2.3 m (L x h), printed on one side - 1 piece;
- ✓ Straight wall, 1 x 2.3 m (L x h), printed on one side - 2 pieces
- ✓ Straight desk large - 1 piece
- ✓ Semiarch 1 x 2.3 x 2 m (L x h x d) printed on both sides - 1 piece
*maximum recommended weight of the screen is 20 kg and the diagonal should be 50 to 110 cm
- ✓ FormTex accessories: LED spot lights - 4 pieces; shelves structure - 1 piece; 90° connecting set - 3 sets



Expo stand Luna



Best Sellers



The product comes in bags



Different dimensions



Fast and easy assembling

Stand for an exhibition area of 6 x 3 m, with 3 open sides, consisting of:

- ✓ Straight wall, 2 x 2.3 m (L x h), printed on one side - 2 pieces
- ✓ Straight desk - 1 piece
- ✓ Semiarch 1 x 2.3 x 2.6 m (L x h x d) printed on both sides - 2 pieces
*maximum recommended weight of the screen is 20 kg and the diagonal should be 50 to 110 cm
- ✓ Straight wall, 2 x 3 m (L x h), printed on one side - 1 piece
- ✓ FormTex accessories: LED spot lights - 2 pieces



Customized dimensions available upon request

Expo stand Dexter



Best Sellers



The product comes in bags



Different dimensions



Fast and easy assembling



Stand for an exhibition area of 6 x 4 m, with 2 open sides, consisting of:

- ✓ Straight wall, 2 x 2.3 m (L x h), printed on one side - 2 pieces
- ✓ Straight wall, 4 x 2.3. m (L x h), printed on one side - 1 piece
- ✓ 3D Straight wall, 2 x 3 m (L x h), printed on one side - 1 piece
*maximum recommended weight of the screen is 20 kg and the diagonal should be 50 to 110 cm
- ✓ Triangle column, 1 x 3 m (L x h), printed on all sides - 1 piece
- ✓ Desk straight large - 1 piece
- ✓ FormTex accessories: LED spot lights - 10 pieces; brochure holder - 1 piece; 90° connecting set - 1 set; TV support for 3D wall - 1 piece



Customized dimensions available upon request

Expo stand Orson



The product comes in bags



Different dimensions



Fast and easy assembling



Stand for an exhibition area of 6 x 3 m, with 2 open sides, consisting of:

- ✓ Straight wall, 3 x 2.3 m (L x h), printed on one side - 1 piece
- ✓ Straight wall, 2.5 x 2.3 m (L x h), printed on one side - 1 piece
- ✓ Straight desk - 1 piece
- ✓ 3D Straight wall 2 x 3 m (L x h), printed on one side - 1 piece
- ✓ Straight arch, 1 x 3 x 3 m (L x h x d), printed on both sides - 1 piece
*maximum recommended weight of the screen is 20 kg and the diagonal should be 50 to 110 cm
- ✓ FormTex accessories: LED spot lights - 9 pieces; brochure holder - 1 piece, TV support for straight Arch - 1 piece



Customized dimensions available upon request

Expo stand Risa



The product comes in bags



Different dimensions



Fast and easy assembling

Stand for an exhibition area of 5 x 5 m, with 3 open sides, consisting of:

- ✓ Straight wall, 3 x 2.3 m (L x h), printed on one side - 1 piece
- ✓ Straight desk large - 2 pieces
- ✓ Straight arch, 2 x 3 x 3 m (L x h x d), printed on both sides - 1 piece
*maximum recommended weight of the screen is 20 kg and the diagonal should be 50 to 110 cm
- ✓ FormTex accessories: LED spot lights - 6 pieces; brochure holder - 1 piece; TV support with shelves - 1 piece
TV support for straight Arch - 1 piece



Customized dimensions available upon request



Expo stand Nola



Best Sellers



The product comes in bags



Different dimensions



Fast and easy assembling

Stand for an exhibition area of 8 x 3 m, with 3 open sides, consisting of:

- ✓ Straight wall, 4 x 2.3 m (L x h), printed on one side - 2 pieces
- ✓ Oval desk - 2 pieces
- ✓ 3D Straight wall 1.5 x 2.3 m (L x h), printed on both sides - 1 piece
*maximum recommended weight of the screen is 20 kg and the diagonal should be 50 to 110 cm
- ✓ FormTex accessories: LED spot lights - 6 pieces; brochure holder - 2 pieces; TV support for 3D wall - 2 pieces



Customized dimensions available upon request



Extra Large Stands

Expo stand Celio



The product comes in bags



Different dimensions



Fast and easy assembling

Stand for an exhibition area of 6 x 6 m, type "island", consisting of:

- ✓ Straight wall, 3 x 2.3 m (L x h), printed on one side - 4 pieces
- ✓ Desk straight - 2 pieces
- ✓ Hanging straight 6 m, printed on one side - 1 piece
- ✓ FormTex accessories: LED spot lights - 8 pieces; brochure holder - 2 pieces; 90° connecting set - 2 sets

Customized dimensions available upon request

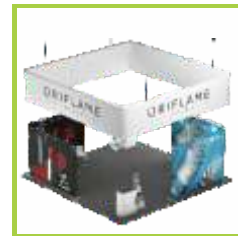

Expo stand Saturn



Best Sellers



The product comes in bags



Different dimensions



Fast and easy assembling

Stand for an exhibition area of 6 x 6 m, with 2 open sides, consisting of:

- ✓ Straight wall, 6 x 2.3 m (L x h), printed on one side - 2 pieces
- ✓ Desk straight - 2 pieces
- ✓ Semiarch 1 x 2.3 x 2.6 m (L x h x d) printed on one side - 2 pieces
*maximum recommended weight of the screen is 20 kg and the diagonal should be 50 to 110 cm
- ✓ A FormTex accessories: LED spot lights - 5 pieces; brochure holder - 2 pieces; 90° connecting set - 1 set

Customized dimensions available upon request

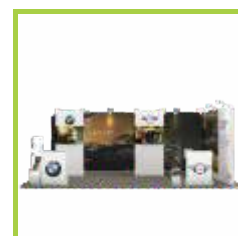

Expo stand Hermes



The product comes in bags



Different dimensions



Fast and easy assembling

Stand for an exhibition area of 6 x 5 m, with 3 open sides, consisting of:

- ✓ Straight wall, 1.5 x 2.3 m (W x H), custom printed one side - 2 pieces
- ✓ Straight desk custom-printed - 2 pieces
- ✓ Straight Arch (1 x 3 x 3 m - W x H x H), custom printed one side - 3 pieces
*maximum recommended weight of the screen is 20 kg and the diagonal should be 50 to 110 cm
- ✓ FormTex accessories: LED spotlights - 14 pieces, TV stand - 3 pieces, brochure stand



Customized dimensions available upon request



Expo stand Gaia



Best Sellers



The product comes in bags



Different dimensions



Fast and easy assembling

Stand for an exhibition area of 10 x 3 m, with 3 open sides, consisting of:

- ✓ Straight wall, 5 x 2.3 m (W x H), custom printed one side - 2 pieces
- ✓ 3D wall, 1.5 x 2.3 m (W x H), custom printed both sides - 1 piece
- ✓ Semiarch custom printed custom printed one side - 2 pieces
*maximum recommended weight of the screen is 20 kg and the diagonal should be 50 to 110 cm
- ✓ Hanging Circle 3 m custom printed one side - 2 pieces
- ✓ Oval desk custom-printed - 2 pieces
- ✓ FormTex accessories - LED spotlights - 6 pieces, brochure stand - 2 pieces, rack with shelves - 2 pieces



Customized dimensions available upon request



Expo Stand Corin



The product comes in bags



Different dimensions



Fast and easy assembling

Stand for an exhibition area of 8 x 5 m, type "island", with storage area, consisting of:



- ✓ 3D Straight wall, 2 x 3 x 2 m (L x h), printed on all sides - 2 pieces
*maximum recommended weight of the screen is 20 kg and the diagonal should be 50 to 110 cm
- ✓ Straight desk - 4 pieces
- ✓ FormTex accessories: LED spot lights - 8 pieces;
Tower shelves - 2 pieces; TV support for 3D wall - 4 pieces

Customized dimensions available upon request



Expo stand Venus



The product comes in bags



Different dimensions



Fast and easy assembling

Stand for an exhibition area of 10 x 5 m, 3 open sides, consisting of:



- ✓ Straight wall, 5 x 2.3 m (L x h), printed on one side - 1 piece
- ✓ Straight wall, 2 x 2.3 m (L x h), printed on one side - 1 piece
- ✓ Straight desk large - 1 piece
- ✓ 3D Straight wall, 3 x 3 x 1 m (L x h x d), printed on one side - 1 piece
- ✓ Hanging straight 3m, printed on one side - 1 piece
- ✓ FormTex accessories: LED spot lights - 11 pieces;

Customized dimensions available upon request



Expo stand Helios



The product comes in bags



Different dimensions



Fast and easy assembling

Stand for an exhibition area of 10 x 5 m, type "island", consisting of:

- ✓ Straight wall, 3 x 2.3 m (L x h), printed on both sides - 1 piece
- ✓ 3D Straight wall, 1 x 3 m (L x h), printed on both sides - 2 pieces
*maximum recommended weight of the screen is 20 kg and the diagonal should be 50 to 110 cm
- ✓ Round arch, 4 x 3 x 1 m (L x h x d), printed on one side - 2 pieces
- ✓ Straight desk - 4 pieces
- ✓ Hanging circle 3 m, printed on one side - 1 piece
- ✓ FormTex accessories: LED spot lights - 2 pieces; TV support for 3D straight wall - 4 pieces

Customized dimensions available upon request



Expo stand Pax



Best Sellers



The product comes in bags



Different dimensions



Fast and easy assembling

Stand for an exhibition area of 10 x 5 m, with 3 open sides, consisting of:

- ✓ Straight wall, 4 x 2.3 m (L x h), printed on one side - 2 pieces
- ✓ 3D Straight wall, 2 x 3 m (L x h), printed on one side - 1 piece
*maximum recommended weight of the screen is 20 kg and the diagonal should be 50 to 110 cm
- ✓ 3D wall, 6 x 1.6 m (L x h), printed on both sides - 1 piece
- ✓ Asymmetric arch, 3.5 x 3/2.3 x 1 m (L x h x d), printed on both sides - 2 pieces
- ✓ Straight desk - 2 pieces
- ✓ FormTex accessories: LED spot lights - 14 pieces; TV support for 3D wall - 1 piece

Customized dimensions available upon request



Expo Stand Ares

- 
 The product comes in bags
- 
 Different dimensions
- 
 Fast and easy assembling

Stand for an exhibition space
8 x 4 m, 2 open sides, consisting of:



- ✓ Straight wall, 4 x 2.3 m (W x H), custom printed one side - 1 piece
- ✓ Straight wall, 3 x 2.3 m (W x H), custom printed one side - 1 piece
- ✓ Straight wall, 2 x 2.3 m (W x H), custom printed one side - 1 piece
- ✓ 3D wall, 1 x 3 m (W x H), custom printed one side - 1 piece
- ✓ Straight Arch (1 x 2.3 x 3 m - W x H x H), custom printed one side - 2 pieces
*maximum recommended weight of the screen is 20 kg and the diagonal should be 50 to 110 cm
- ✓ Straight desk custom-printed - 2 pieces
- ✓ FormTex accessories - LED spotlights - 7 pieces,
 90° connection accessories - 1 set, brochure stand, TV stand with shelves, TV stand - 2 pieces



Expo stand Mars

- 
 The product comes in bags
- 
 Different dimensions
- 
 Fast and easy assembling

Stand for an exhibition area of 6 x 5 m,
2 open sides, consisting of:



- ✓ Straight wall, 2 x 2.3 m (W x H), custom printed one side - 2 pieces
- ✓ Straight wall, 4 x 2.3 m (W x H), custom printed one side - 1 piece
- ✓ 3D wall, 1 x 3 m (W x H), custom printed one side - 1 piece
- ✓ 3D Straight wall, 3 x 3 x 1 m (L x h x d), printed on one side - 1 piece
*maximum recommended weight of the screen is 20 kg and the diagonal should be 50 to 110 cm
- ✓ Straight desk custom-printed - 2 pieces
- ✓ FormTex accessories - LED spotlights - 6 pieces,
 90° connection accessories - 1 set, TV stand, brochure stand - 2 pieces, rack with shelves - 2 pieces

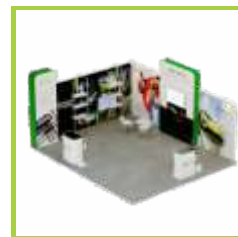

Customized dimensions available upon request

Assembling the LightBox structures

The portable LED LighBox is made of anodized aluminum modular frame with a width of 12 cm. Its 2 fabric printed sides are uniformly illuminated from interior over their entire area with high power LED spotlights.

The set-up is done without tools or previous technical knowledge, by simply following a few easy steps in the instructions manual. The magnetized connectors of the cables make their connection to the sockets very easy.

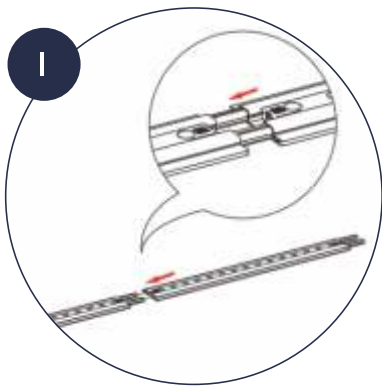

The set-up is done without tools or previous technical knowledge, by simply following a few easy steps.

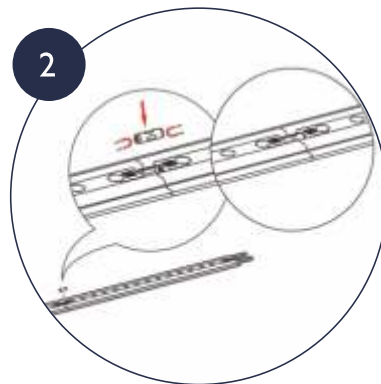

The magnetized connectors of the cables make their connection to the sockets very easy.



Tool-less down to its feet, is designed to help heighten your display experience



Guaranteed impact - bright and intense colors through light projected from interior

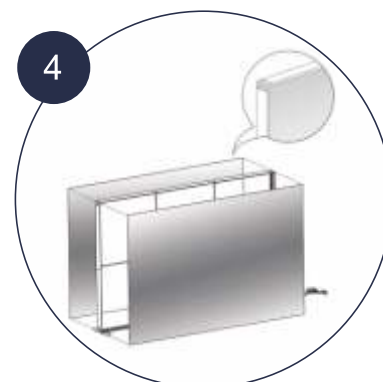

Now, it's time to install the graphics. Tilt the frame over for setup. Begin by inserting the silicone edge inside the frame, starting with the corners, then progressing to the middle edges

Small stands

Expo stand LED Minerva



The product comes in bags



Different dimensions



Fast and easy assembling

Stand for an exhibition area of 3 x 3 m, 3 open sides, consisting of:

- ✓ Portable light box 2 x 2.5 m (W x H), customized 2 sides - 1 piece
- ✓ Portable light box 1 x 2.5 m (W x H), customised 2 sides - 1 piece
- ✓ Portable light desk 1 x 1 m (W x H), customised 2 sides - 1 piece
- ✓ Lightbox accessories: 180° connectors, TV bracket for lightbox 1m, Shelf for lightbox 1m - 2 pieces



Customized dimensions available upon request

Expo stand LED Jupiter



Best Sellers



The product comes in bags



Different dimensions



Fast and easy assembling

Stand for an exhibition area of 3 x 3 m, 3 open sides, consisting of:

- ✓ Portable light box 2 x 2.5 m (W x H), customized 2 sides - 1 piece
- ✓ Portable light box 1 x 2.5 m (W x H), customized 2 sides (storage space with door) - 4 pieces
- ✓ Portable light desk 1 x 1 m (W x H), customised 2 sides - 1 piece
- ✓ Lightbox accessories: door kit, 180° connectors



Customized dimensions available upon request

Expo stand LED Mira



The product comes in bags



Different dimensions



Fast and easy assembling

Stand for an exhibition area of 3 x 3 m, 1 open side, consisting of:

- ✓ Portable light box 3 x 2.5 m (W x H), customized 2 sides - 1 piece
- ✓ Portable light box 2 x 2.5 m (W x H), customised 2 sides - 1 piece
- ✓ Portable light desk 1 x 1 m (W x H), customised 2 sides - 1 piece
- ✓ Lightbox accessories: 90° connectors, mini foot - 2 piece



Customized dimensions available upon request



Expo stand LED Cer



Best Sellers



The product comes in bags



Different dimensions



Fast and easy assembling

Stand for an exhibition area of 3 x 3 m, 3 open sides, consisting of:

- ✓ Portable light box 3 x 2.5 m (W x H), customized 2 sides - 1 piece
- ✓ Portable light box 1 x 2.5 m (W x H), customised 2 sides (arch leg) - 1 piece
- ✓ Portable light box 1 x 2 m (W x H), customised 2 sides (arch roof) - 1 piece
- ✓ Portable light desk 1 x 1 m (W x H), customised 2 sides - 1 piece
- ✓ Lightbox accessories: TV bracket for lightbox 1m, Arch kit - 3 m box mount



Customized dimensions available upon request



Expo stand LED Pluto



The product comes in bags



Different dimensions



Fast and easy assembling

Stand for an exhibition area of 3 x 3 m, 2 open sides, consisting of:

- ✓ Portable light box 3 x 2.5 m (W x H), customised 2 sides - 1 piece
- ✓ Portable light box 2 x 2.5 m (W x H), customised 2 sides - 1 piece
- ✓ Portable light box 1 x 2.5 m (W x H), customised 2 sides (arch legs) - 2 pieces
- ✓ Portable light box 1 x 2 m (W x H), customised 2 sides (arch roof) - 1 piece
- ✓ Portable light desk 1 x 1 m (W x H), customised 2 sides - 1 piece
- ✓ Lightbox accessories: 90°/180° connectors, mini foot, Arch kit

Customized dimensions available upon request



Large stands

Expo stand LED Artemis



The product comes in bags



Different dimensions



Fast and easy assembling

Stand for an exhibition area of 6 x 3 m, 3 open sides, consisting of:

- ✓ Portable light box 3 x 2.5 m (W x H), customised 2 sides - 2 pieces
- ✓ Portable light box 1 x 2.5 m (W x H), customised 2 sides (arch legs) - 2 pieces
- ✓ Portable light box 1 x 2 m (W x H), customised 2 sides (arch roof) - 2 piece
- ✓ Portable light desk 1 x 1 m (W x H), customised 2 sides - 1 piece
- ✓ Lightbox accessories: TV bracket for lightbox 1m - 2 pieces, Arch Kit - 3m box mount - 2 pieces, 180° connectors

Customized dimensions available upon request

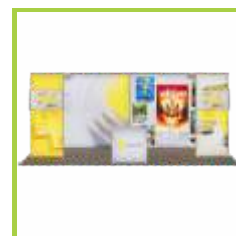

Expo stand LED Hera



The product comes in bags



Different dimensions



Fast and easy assembling

Stand for an exhibition area of 6 x 3 m, 3 open sides, consisting of:

- ✓ Portable light box 3 x 2.5 m (W x H), customised 2 sides - 2 pieces
- ✓ Portable light box 1 x 2.5 m (W x H), customised 2 sides (storage space with door) - 3 pieces
- ✓ Portable light box 1 x 2.5 m (W x H), customised 2 sides (arch leg) - 1 piece
- ✓ Portable light box 1 x 2 m (W x H), customised 2 sides (arch roof) - 1 piece (arch roof) - 1 piece
- ✓ Portable light desk 1 x 1 m (W x H), customised 2 sides - 1 piece
- ✓ Lightbox accessories: TV bracket for lightbox 1m - 1 piece, Arch kit - 1 piece, Door kit - 1 piece, 180° connectors

Customized dimensions available upon request



Expo stand LED Rhea



Best Sellers



The product comes in bags



Different dimensions



Fast and easy assembling

Stand for an exhibition area of 6 x 3 m, 3 open sides, consisting of:

- ✓ Portable light box 2 x 2.5 m (W x H), customised 2 sides - 2 pieces
- ✓ Portable light box 1 x 2.5 m (W x H), customised 2 sides (arch legs) - 4 pieces
- ✓ Portable light box 1 x 2 m (W x H), customised 2 sides (arch roof) - 2 piece
- ✓ Portable light desk 1 x 1 m (W x H), customised 2 sides - 1 piece
- ✓ Lightbox accessories: TV bracket for lightbox 1m - 2 pieces, Arch kit - 2 pieces, 180° connectors

Customized dimensions available upon request



Extra Large Stands

Expo stand LED Diana

-  The product comes in bags
-  Different dimensions
-  Fast and easy assembling

Stand for an exhibition area of 5 x 5 m, 2 open sides, consisting of:

- ✓ Portable light box 3 x 2.5 m (W x H), customized 2 sides - 2 pieces
- ✓ Portable light box 2 x 2.5 m (W x H), customised 2 sides (storage space sides) - 2 pieces
- ✓ Portable light box 1 x 2.5 m (W x H), customised 2 sides - 1 piece
- ✓ Portable light box 1 x 2.5 m (W x H), customised 2 sides, (storage space with door) - 1 piece
- ✓ Portable light desk 1 x 1 m (W x H), customised 2 sides - 1 piece
- ✓ Lightbox accessories: TV holder for lightbox 1m - 1 piece, Door kit, 180° connectors, Lightbox Mini Foot - 2 pieces

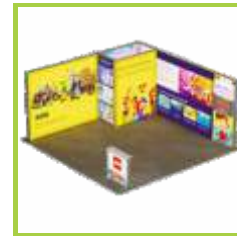

Customized dimensions available upon request

Expo stand LED Iris

-  Best Sellers
-  The product comes in bags
-  Different dimensions
-  Fast and easy assembling

Stand for an exhibition area of 9 x 3 m, 3 open sides, consisting of:

- ✓ Portable light box 3 x 2.5 m (W x H), customized 2 sides - 2 pieces
- ✓ Portable light box 1 x 2.5 m (W x H), customised 2 sides (arch legs) - 4 pieces
- ✓ Portable light box 1 x 2 m (W x H), customised 2 sides (arch roof) - 2 piece
- ✓ Portable light desk 1 x 1 m (W x H), customised 2 sides - 1 piece
- ✓ Lightbox accessories: door kit, 180° connectors

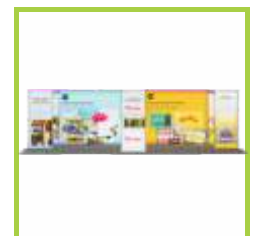

Customized dimensions available upon request

Recent productions

